

Kessil

LED Aquarium Light

A360 X

Tuna Blue | Tuna Sun



Inside the Box

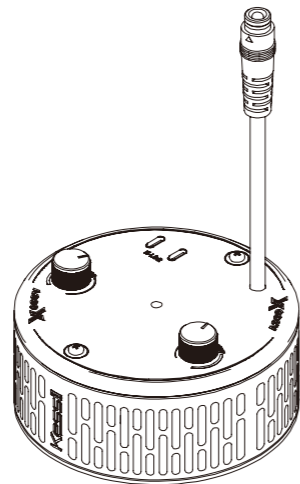

A360X x 1

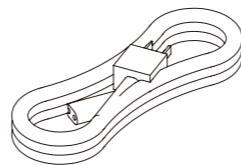

AC Adapter Cable (6 feet) x 1

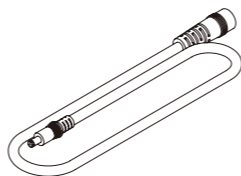

DC Power Extension Cable (6 feet) x 1

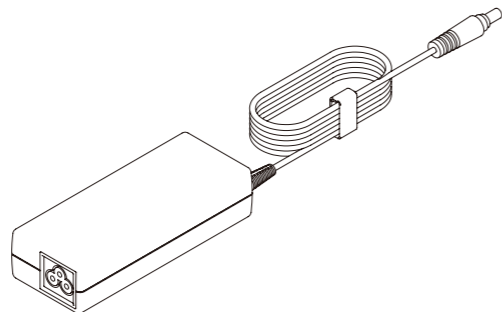

Power Adapter x 1



Hanging Bracket x 2



Hanging Ring x 1

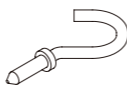

Screw Hook x 2

Parts Diagram

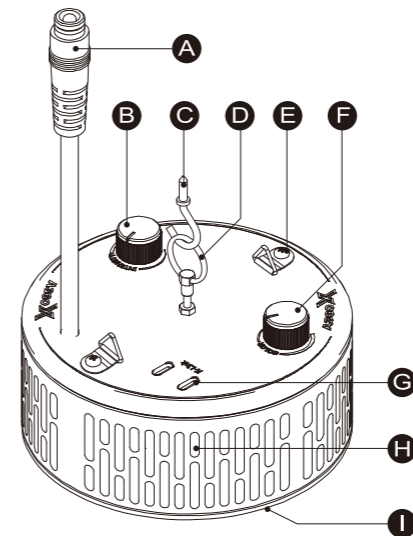

- A Power Cord
- B Intensity Tuning Knob
- C Screw Hook
- D Hanging Ring
- E Hanging Bracket
- F Color Tuning Knob
- G K-Link
- H Venting Holes
- I Lens

Safety Instructions

1. DO NOT use a power adapter that is out of the specifications. This is a fire hazard and may lead to unit failure.
2. DO NOT use outdoors. This unit is intended for indoor use only.
3. DO NOT expose unit to an extremely humid environment or submerge unit in water. This may lead to unit failure.
4. DO NOT place working illuminator in close contact with any objects. This may cause objects to heat up and the unit to overheat.
5. KEEP Lens (I) away from sharp objects. Sharp objects may break the lens and lead to unit failure.
6. DO NOT cover or place objects on the power adapter. Power adapter should not be contained in an airtight space.

Instructions de Sécurité

1. N'utilisez PAS une source d'alimentation qui est en dehors des spécifications. Ceci constitue un risque d'incendie et peut entraîner une défaillance de l'unité.
2. NE PAS utiliser à l'extérieur. Cette unité est destinée à une utilisation en intérieur uniquement.
3. NE PAS exposer l'appareil à un environnement extrêmement humide ou immerger l'appareil dans l'eau. Cela peut entraîner une défaillance de l'unité.
4. NE placez PAS l'illuminateur de travail en contact étroit avec des objets. Cela peut provoquer un échauffement des objets et une surchauffe de l'appareil.
5. GARDEZ l'objectif (I) à l'écart des objets pointus. Des objets pointus peuvent casser l'objectif et entraîner une défaillance de l'unité.
6. NE PAS couvrir ou placer d'objets sur l'alimentation électrique. L'alimentation ne doit pas être contenue dans un espace étanche à l'air.



Getting Started

Step 1 Power

Connect the A360X to the power adapter and plug it into a wall outlet. Turn the Intensity Tuning Knob (B) to the right to turn on the light.

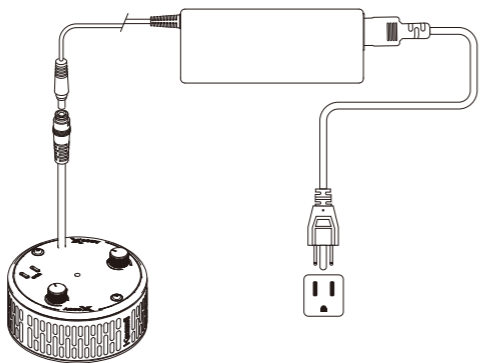

Step 2 Control

- Turn the Intensity Tuning Knob (B) to adjust the brightness of the fixture.
- Turn the Color Tuning Knob (F) to set the fixture to the desired color.
- A360X can be connected and controlled through Kessil Spectral Controller X with a Type-C USB Cable (K-Link Cable).

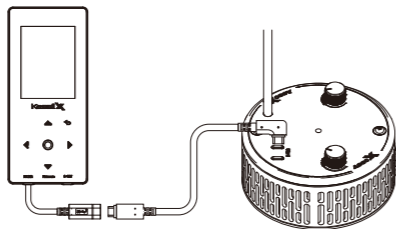

(Controller X not included)

Step 3 Controlling Multiple A360X

- Connect two or more lights with K-Link Cables as shown below.
- Multiple A360X lights can be controlled by either a single external controller or manually.
- When controlling without an external controller, tuning controls on any light control all other lights in chain.

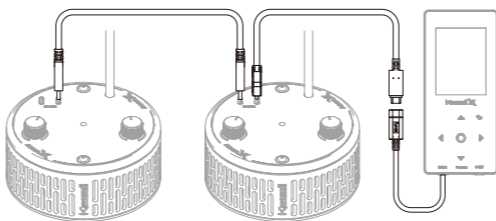

Step 4 Mounting

- Screw the Hanging Ring (D) into the center screw hole.
- Hang the light with the two Screw Hooks (C) and the two Hanging Brackets (E).
- To install the Hanging Brackets (E), remove the screws on the A360X, use the same screws to secure the fasteners with tri-hooks onto the light fixture.

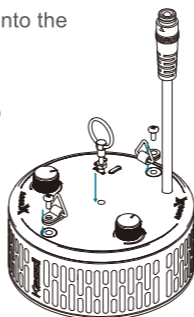

Maintenance

1. Keep the air intake holes, Venting Holes (H), and fan clear of dust. To clean the fan, unplug the unit and insert the tip of a CO2 dust blower (or similar dust blower) in one of the Venting Holes (H) on the unit's outer shell. Hold and spray. You can also gently vacuum out the light through the venting holes.
2. Keep the Lens (I) clean. If the lens becomes contaminated with water, dust, or other particles, unplug the unit and clean the lens with isopropyl alcohol. Wet a cotton swab or a napkin in isopropyl alcohol, gently wipe the surface of the lens, and let it dry.

Troubleshooting Guide

Please make sure to perform maintenance before doing any troubleshooting.

Problem	Cause / Solution
Light doesn't turn ON	Make sure the unit is connected to the power adapter and the power adapter is plugged into an outlet with the correct specifications.
	Make sure the power adapter has the right specifications.
	Make sure electrical power is available to the AC outlet being used.
Unit is flickering	Make sure the device is operating within the specified operating temperature range. If unit overheats, it will automatically shut down.
	Make sure the power adapter has the right specifications.
	Make sure the unit has not overheated by operating at a room temperature above 100°F/40°C.
	Make sure the fan is operating properly.

Product Specification

Illuminator	
Power Consumption	90W MAX
Input Voltage	19 VDC

Listed Power Adapter	
Input	100-240 VAC, 47-63 Hz, 1.5 A MAX
Output	19 VDC, 4.74A

kessil.led

kessiltube

@kessilled

kessil.com

Kessil Lighting

A DiCon Brand

1689 Regatta Blvd, Richmond, CA 94804

(510) 620-5250

www.kessil.com



IOTA USER GUIDE

Control of Kessil A360X and AP9X lighting with APEX



CONTENTS

INTRODUCTION.....	2
REQUIREMENTS	2
SYSTEM ARCHITECTURE	2
PREPARING YOUR KESSIL LIGHT TO BE CONTROLLED BY THE APEX.....	8
PROVIDING POWER TO YOUR KESSIL LIGHT	9
UPDATING YOUR APEX AOS	10
ATTACHING A KESSIL LIGHT TO THE APEX USING THE APEX FUSION IOTA TASK.....	11
ATTACHING A KESSIL LIGHT TO THE APEX USING THE MODULES LIST IN APEX LOCAL OR APEX FUSION.....	14
OUTPUTS AND DASHBOARD TILES FOR IOTA-ATTACHED DEVICES	16
MIGRATING A LIGHTING SCHEDULE FROM KESSIL APP TO APEX.....	18
CREATING A SCHEDULE FOR YOUR KESSIL LIGHT	21
LIGHTING SCHEMES	24
ADDITIONAL INFORMATION	24
CHANGE LOG	25

INTRODUCTION

This guide will assist you in setting up Kessil A360X Tuna Sun™, A360X Tuna Blue™, and AP9X™ LED lighting fixtures to be controlled by an Apex controller system. The A360X Refugium™ and A500™ models are not currently supported.

In this guide, you will see references to IoTa and IOTA. IoTa is an acronym of **Internet of Things: Aquarium**. IoTa is the name of an initiative created by Neptune Systems to standardize and facilitate development of Apex control of Internet-connected aquarium equipment such as the Kessil A360X™ and AP9X™ LED lights.

REQUIREMENTS

- An Apex or ApexEL is required; this capability is not available in Apex Classic models, which include the Apex Classic, Apex Gold, Apex Lite, and Apex Jr.
- The Apex must have AOS version 5.06_7F21 (or later) installed.
- The Apex must be connected to the local network via Wi-Fi or Ethernet.
- The Kessil LED lights which will be directly controlled by the Apex must be connected over Wi-Fi to the same network as the Apex.

SYSTEM ARCHITECTURE

- Kessil A360X Tuna Blue and Tuna Sun lights equipped with a WiFi Dongle may be directly controlled by the Apex.
- Kessil A360X lights *of the same model (Tuna Sun or Tuna Blue)* which are not equipped with a WiFi Dongle may be connected to an A360X controlled by an Apex by using a K-Link cable; additional A360X without WiFi Dongles may be daisy-chained with K-Link. If the Kessil lights are connected this way, the daisy-chain lights will mirror the light being controlled by the Apex.
- Kessil AP9X lights in Apex-controlled mode will be directly controlled by the Apex.
- Kessil AP9X lights not in Apex-controlled mode may be connected to an AP9X controlled by an Apex by using a K-Link cable; additional AP9X may be daisy-chained with K-Link.
- Each IoTa device being directly controlled by an Apex counts as an Apex module and is subject to the Apex limit of 49 modules.



Do not mix light models and variants of the same model in the same K-Link chain.

- ⊘ Do not link AP9X and A360X with Wi-Fi Dongle together using K-Link.
- ⊘ Do not link A360X Tuna Sun and A360X Tuna Blue lights together using K-Link.

If you have multiple lights of the same model and type, and you wish to control all lights together with the same lighting schedule, then only one AP9X or one WiFi Dongle-equipped A360X should be in Apex-controlled mode, and other lights be daisy-chained from that light. This configuration offers simplicity; only the Apex-controlled light needs to have a lighting schedule assigned in the Apex; the other lights will automatically follow that same schedule.

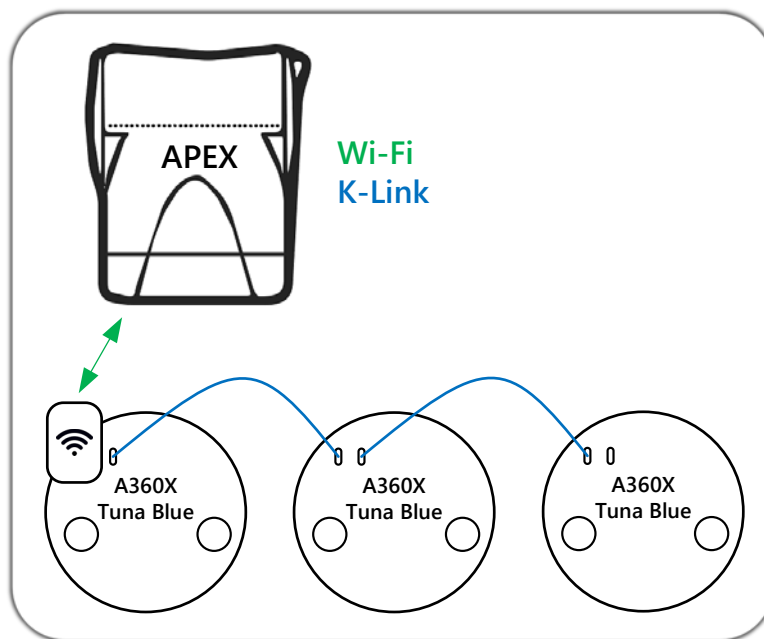

Apex controlling a K-Link chain of A360X

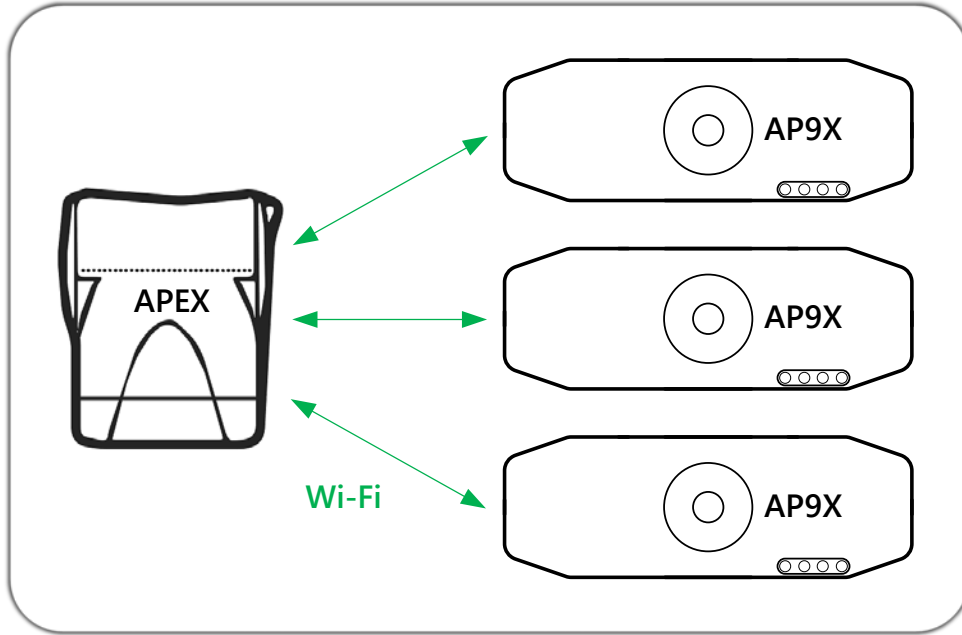

Apex controlling a K-Link chain of AP9X

If you have multiple lights of the same model and type (A360X Tuna Sun or A360X Tuna Blue), and you wish to control each light independently, each light must have a dongle and each should be configured in Apex-controlled mode. This offers the most flexibility, but the lighting schedule for each light must be set separately.

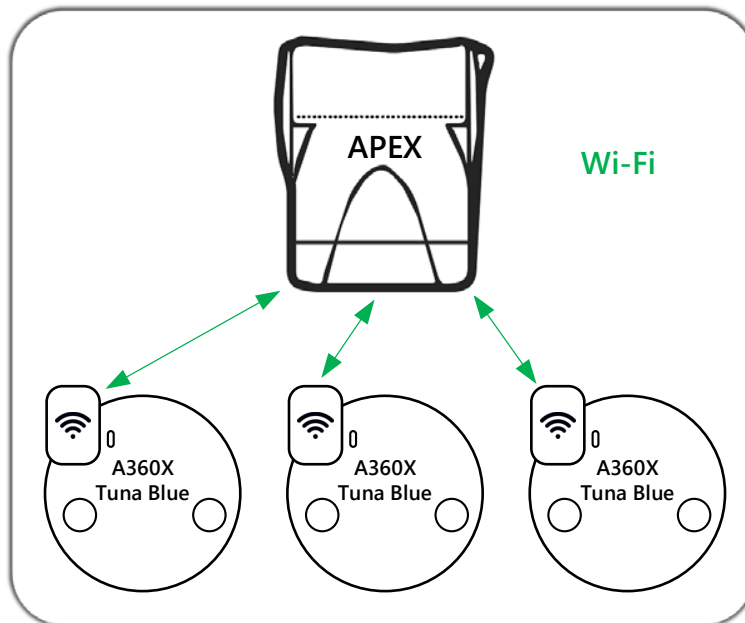

Apex independently controlling three A360X

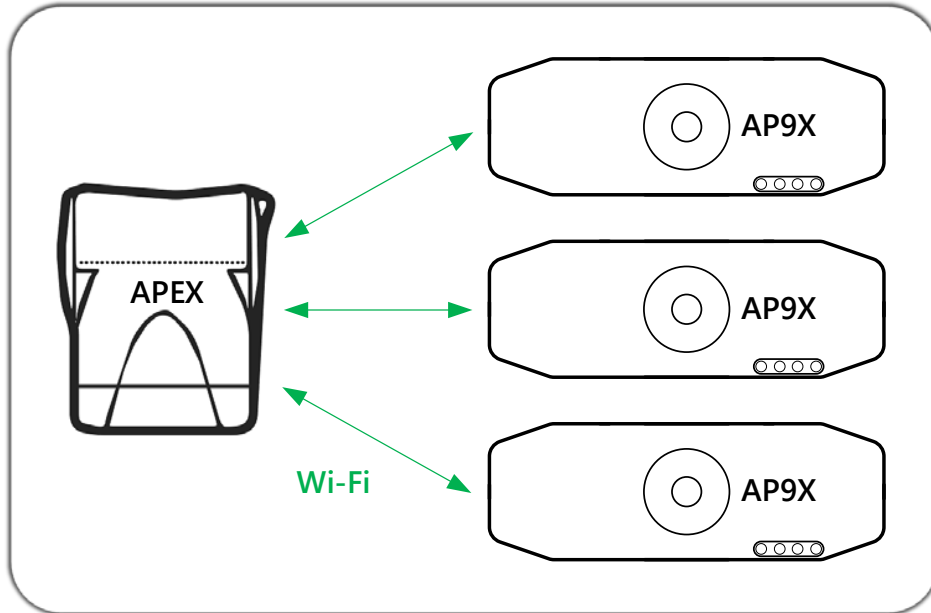

Apex independently controlling three AP9X

If you have both AP9X lights and A360X lights, you may control each light individually, or you may form two chains of K-Linked lights of the same model.

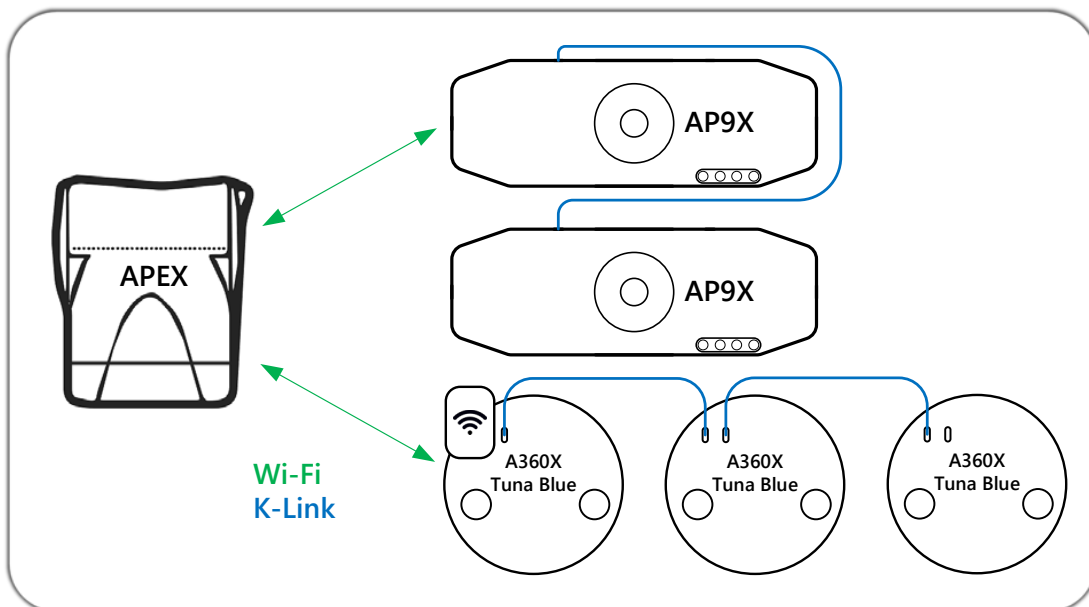

Apex controlling chains of both AP9X and A360X

The Apex supports a maximum of 12 IoTa devices of any type, which includes:

- Kessil A360X equipped with a WiFi Dongle and configured in Apex control mode
- Kessil AP9X configured in Apex control mode
- Aqualllumination Prime, Prime HD, Hydra 26HD, and Hydra 52HD under Apex control
- Sicce Syncra SDC™ pumps and XStream SDC™ pumps which have been upgraded for IoTa and Apex control

This limit applies to all IoTa devices on the local wireless network; there can be no more than 12 present.

Examples:

1. You have (6) A360X equipped with WiFi Dongles, (2) Sicce Syncra SDC pumps, and (2) Sicce XStream SDC power heads. This is a total of 12 IoTa devices, and all of these devices may be controlled by a single Apex, or some may be controlled by one Apex, and other controlled by another Apex.
2. You have (6) A360X equipped with WiFi Dongles, (2) AP9X, (2) Sicce Syncra SDC pumps, and (2) Sicce XStream SDC power heads. This is a total of 14 devices, which exceeds the limit of 12. To reduce the number of devices present on the network, use K-Link cables to daisy-chain the AP9X lights, some of the A360X, or some combination thereof as needed to reduce the totally quantity of IoTa devices to 12 or less.

For larger installations involving more than 12 Kessil lights, special consideration must be given to ensure the 12 item limit is observed. For stores, coral farms, etc., it will generally be optimal to handle raceways or rows of frag tanks with one light being directly Apex-controlled, and the remaining lights in each row or each raceway be daisy-chained using K-Link.

Let's take a store as an example.

- It has 3 saltwater display tanks in the showroom, each with 2 AP9X
- Each display tank's pair of lights must be able to be controlled separately
- The store also has 3 long rows of frag tanks, each with 8 A360X
- All frag tanks in any given row can have the same lighting schedule, but each row must be able to have a different schedule
- Each display tank has a dedicated Apex system
- Each row of frag tanks has a dedicated Apex system

To meet these goals and to stay within the limit of 12 active IoTa devices, the lighting could be configured using a mixture of some lights with direct Apex control and the remaining lights daisy-chained from those lights, as seen in this image:

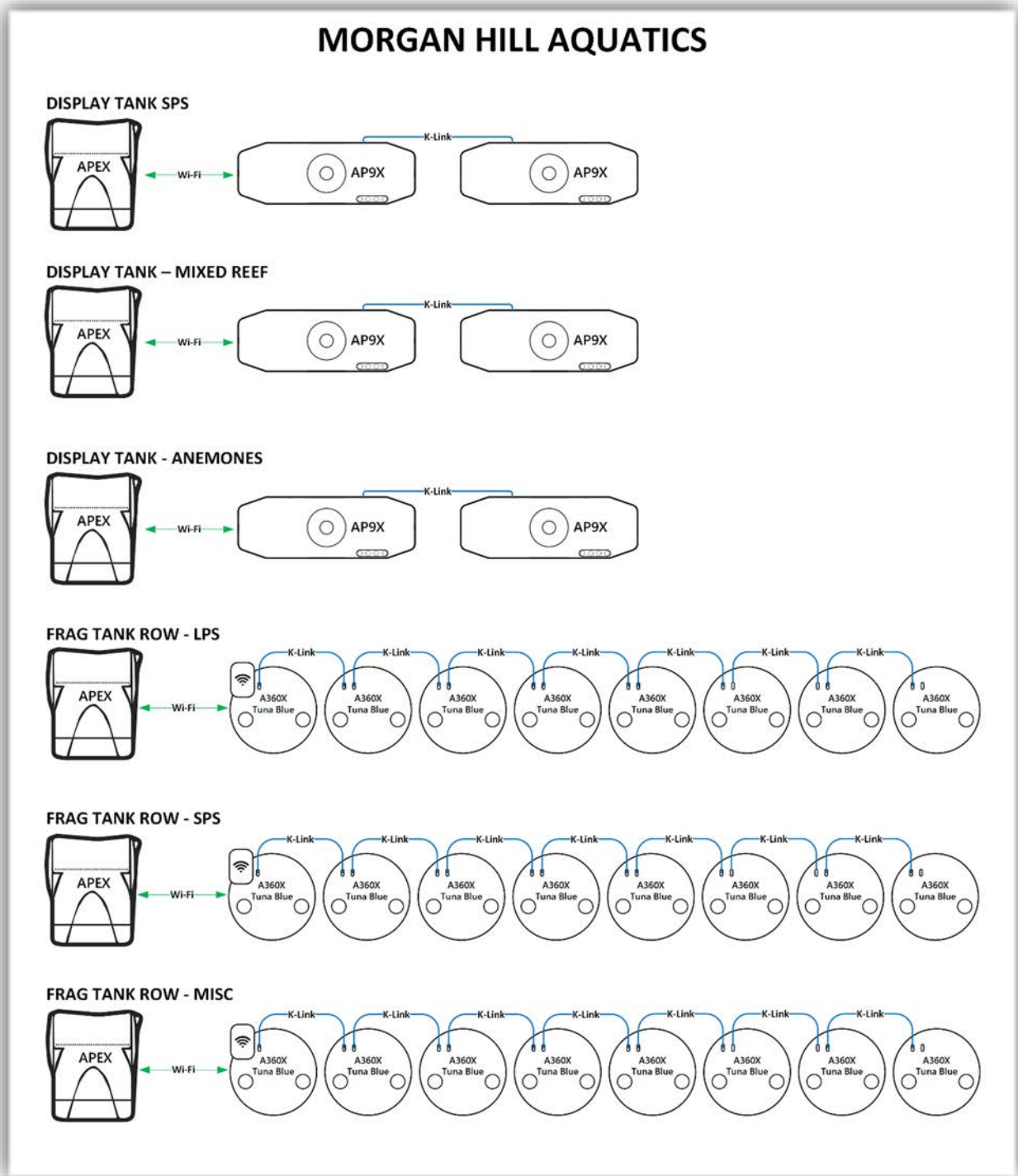

The depicted layout offers simplicity and ease of use, has the flexibility to meet the different requirements of the various types of livestock, yet still allows ample room for growth.

PREPARING YOUR KESSIL LIGHT TO BE CONTROLLED BY THE APEX



If you are changing existing Kessil lighting from control via the Kessil WiFi app to Apex control, take screenshots or make notes about your current lighting schedule now so you can recreate your current lighting schedule in the Apex after the lights are under Apex control.

After installing the latest version of the Kessil WiFi app:

1. Reset all lights (AP9X and WiFi Dongle-equipped A360X).
2. Reset the app; tap Settings at the bottom, then tap Reset App.

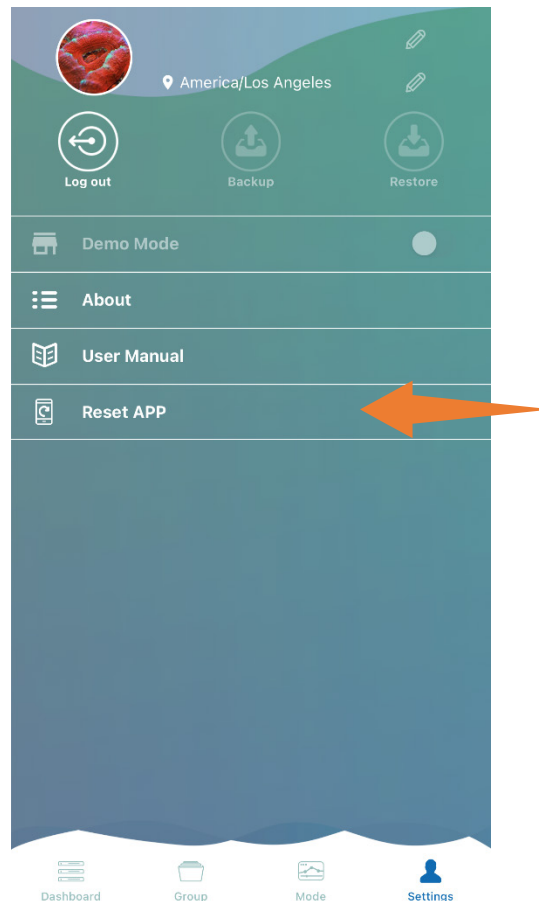

3. Follow the setup instructions in the [Kessil WiFi app manual](#). Use the “Through Wireless Router” method **after** enabling the **Apex Fusion control ONLY** option. When performing this step, the AP9X or the WiFi Dongle must be configured to connect to the same network as the Apex which will be used to control it.



If a firmware update is available for the AP9X or the WiFi Dongle, it will be installed during the process of configuring the Kessil light for your wireless network.

4. When the configuration process through the app has completed, it will be ready to attach to your Apex.



After you complete the setup of each AP9X or WiFi Dongle-equipped A360X with *Apex Fusion control ONLY* enabled, it will no longer be visible in the app.

PROVIDING POWER TO YOUR KESSIL LIGHT



The power supplies for A360X and AP9X lights do not need to be plugged into an EnergyBar outlet; instead, they should be plugged into a regular wall outlet or power strip. Neptune Systems recommends that the power supplies for A360X and AP9X lights not be plugged into an EnergyBar outlet. However, if you do, the EnergyBar outlet should be programmed to be always ON. You can use the APEX Fusion “Always” Task to

configure the EnergyBar outlet to be always On, or if you prefer to program it yourself, use this simple program:

Fallback ON
Set ON

In APEX Fusion, the “Always” Task may be found by clicking on the **Tasks**  button.

UPDATING YOUR APEX AOS

Your Apex must have AOS version 5.06_7F21 or later installed. You can check for the availability of a newer AOS than installed and install an AOS update if one is available using either APEX Local or APEX Fusion. On the **Dashboard** , click the **Expand**  button, then click the **Network**  button.

The page will either show that no update is needed, or that an AOS is available to install.

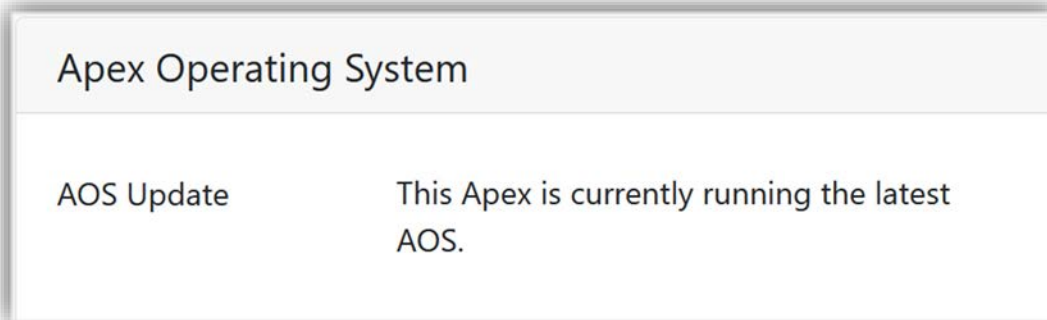

- or -

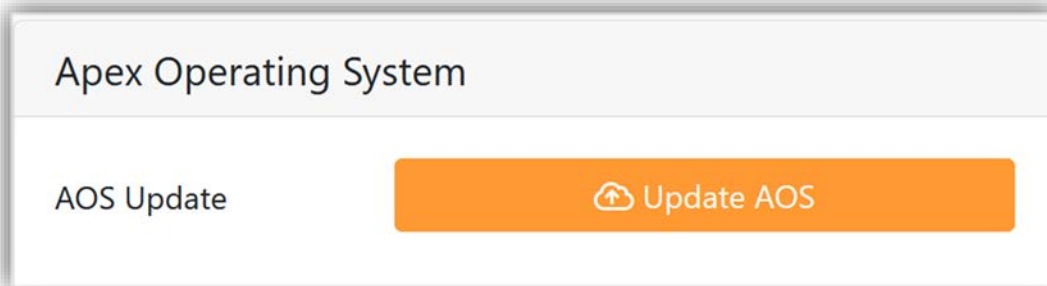

If an update is available, click the  **Update AOS** button, then follow the prompts. Wait at least 15 minutes after the AOS update process completes before proceeding.

ATTACHING A KESSIL LIGHT TO THE APEX USING THE APEX FUSION IOTA TASK

The process of configuring an Apex to control an A360X™ or AP9X™ is called “attaching”. The simplest and preferred method of attaching an A360X™ or AP9X™ is by use of the IOTA Task in APEX Fusion (not APEX Local). While viewing your Apex dashboard, click on the **Tasks**  button; then click on the IOTA Task:

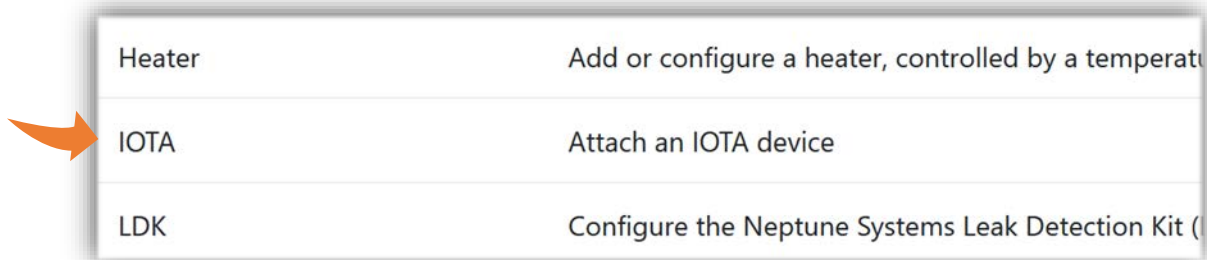

Follow the IOTA Task steps. Step 1 is a summary of what the task does and the basic requirements to be able to attach the Kessil light to the Apex:

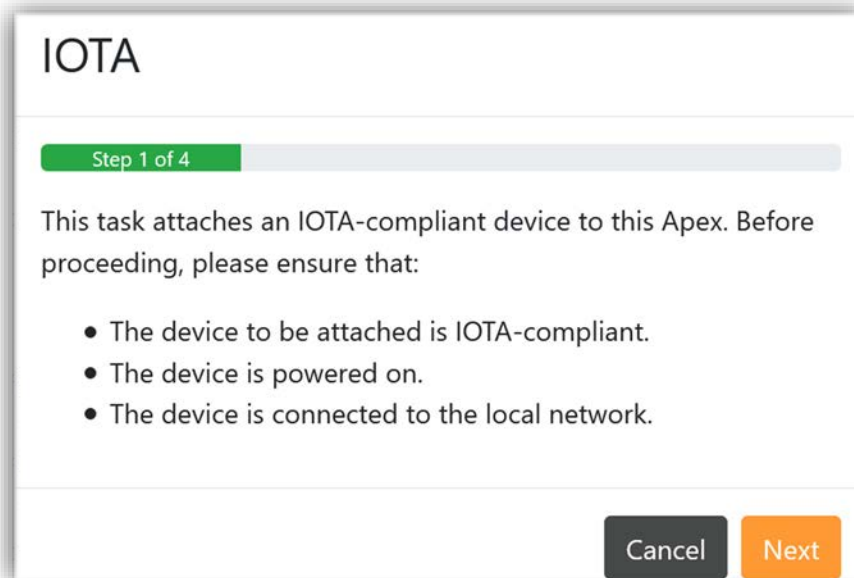

In Step 2, you will be presented a list of all compatible lights and pumps that the Apex has discovered on your network and which are not already attached to this Apex. In the image below, you can see that one AP9X and one Wifi Dongle (A360X) were found. The Serial displayed here is the same as the one printed on the QR-Code stickers which came with your lights. Click on the light you wish to attach, then click the **Next** button.

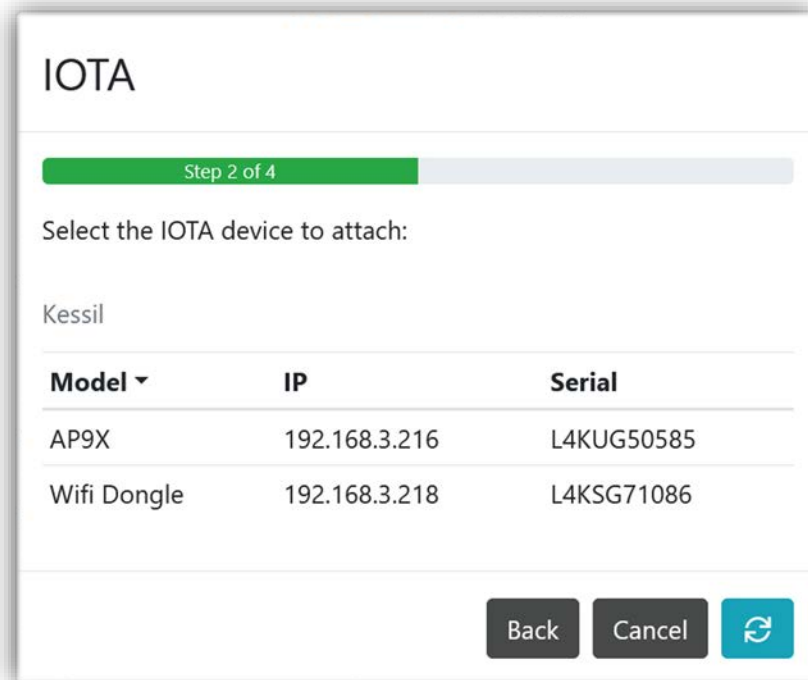

Some IoTa devices may optionally be configured with a password, or may require the use of a password when setting this up for control by an Apex. Kessil lights do not use a password. In Step 3, just skip the password entry and click the **Next** button.

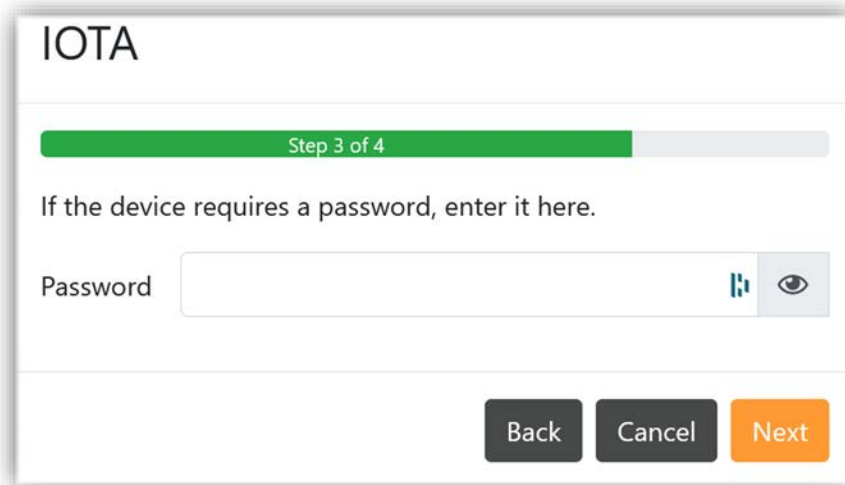

IOTA

Step 3 of 4

If the device requires a password, enter it here.

Password

Back Cancel Next

Step 4 summarizes the action to be taken. Click the **Send** button to finish the IOTA Task.

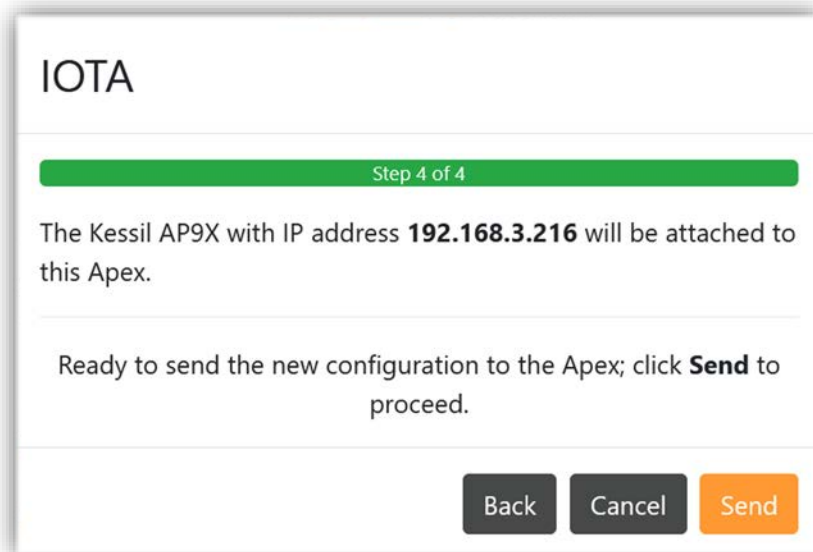

IOTA

Step 4 of 4

The Kessil AP9X with IP address **192.168.3.216** will be attached to this Apex.



Ready to send the new configuration to the Apex; click **Send** to proceed.

Back Cancel Send

Run the IOTA Task again for each additional Kessil light to be attached.

ATTACHING A KESSIL LIGHT TO THE APEX USING THE MODULES LIST IN APEX LOCAL OR APEX FUSION

As an alternative to using the APEX Fusion IOTA Task, A360X or AP9X lights may be attached using the Modules view in either APEX Fusion or APEX Local.

While viewing your Apex dashboard, click on the **Expand**  button, then click the **Modules**  button. A listing of all connected modules will be shown:

1	Disp_1	Display	✓
2	EB832_2	EB832	✓
3	COR_3	COR	✓
4	1LNK_4	1Link	✓

Click on the **Add IOTA Module**  button in the upper right. You will be presented with a list of all compatible IoTa devices that the Apex has discovered on your network and which are not already attached to this Apex. In the image below, you can see that one AP9X and one WiFi Dongle (A360X) were found. The Serial displayed here is the same as the one printed on the QR-Code stickers which came with your lights. Click on the line for Kessil light you wish to attach, then click the **OK** button.

Add IOTA Module
✕

Select a module to attach to this Apex.

Kessil

Model ▾	IP	Serial
AP9X	192.168.3.216	L4KUG50585
Wifi Dongle	192.168.3.218	L4KSG71086

Cancel
OK

Some IoTa devices may optionally be configured with a password, or may require the use of a password when setting this up for control by an Apex. Kessil lights currently do not use a password. Skip the password entry and click the **OK** button.

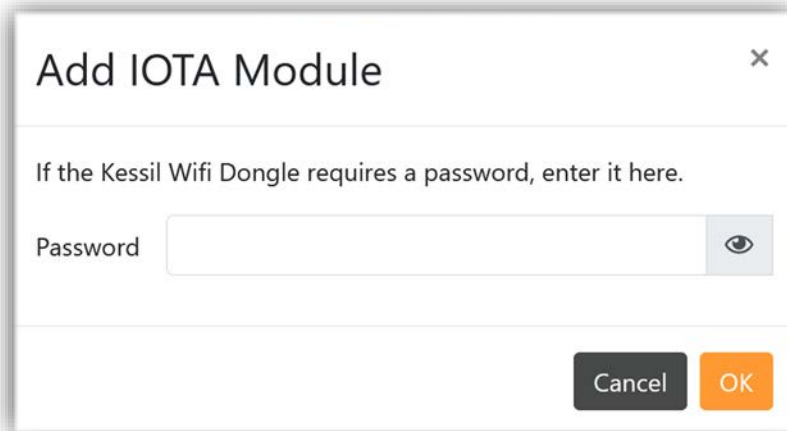

The dialog box titled "Add IOTA Module" contains a close button (X) in the top right corner. Below the title, there is a text prompt: "If the Kessil Wifi Dongle requires a password, enter it here." Underneath this prompt is a text input field labeled "Password" with a toggle eye icon to its right. At the bottom of the dialog, there are two buttons: a grey "Cancel" button and an orange "OK" button.

You will be returned to the Modules view. If you are using APEX Local, wait 5-10 seconds, then click the Refresh  button. You should now see a new module named IOTA_# where # is the Aquabus address which the Apex assigned for newly-attached Kessil light. It may take a minute or so if you are using APEX Fusion before the newly-added light appears as a module.

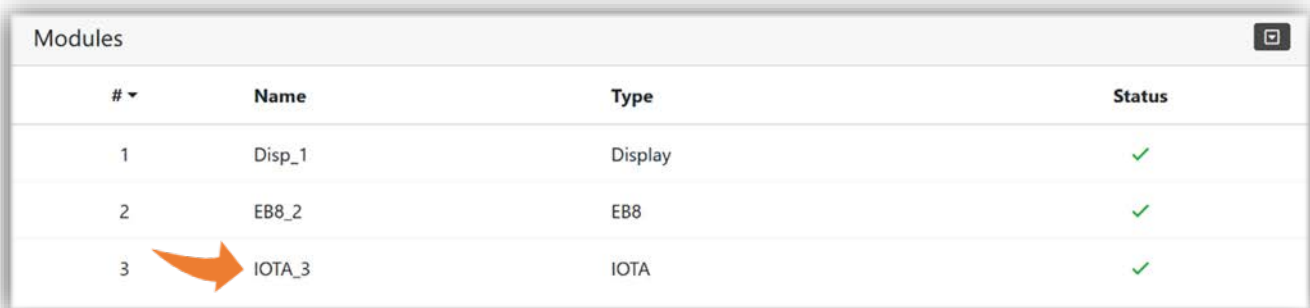

#	Name	Type	Status
1	Disp_1	Display	✓
2	EB8_2	EB8	✓
3	IOTA_3	IOTA	✓

An orange arrow points to the "IOTA_3" entry in the table.

Repeat this process for any additional Kessil lights you wish to connect. In the image below, you can see that two Kessil IoTa devices have been attached and have been assigned Aquabus addresses 3 & 4.

Modules			
#	Name	Type	Status
1	Disp_1	Display	✓
2	EB8_2	EB8	✓
3	IOTA_3	IOTA	✓
4	IOTA_4	IOTA	✓

OUTPUTS AND DASHBOARD TILES FOR IOTA-ATTACHED DEVICES



When IoTa devices such as A360X or AP9X are attached to the Apex, new outputs and dashboard tiles will automatically be created. Outputs will appear in the **Outputs** view. The Apex outputs for the A360X and AP9X which were attached earlier can be seen in this image:

Outputs	
Name	Type
ALARM	Alarm
ATS	Outlet
Cabinet	Outlet
KessilTB_3_1	Light
KessilTB_4_1	Light
ReturnPump	Outlet
Skimmer	Outlet
SedAlm_16	Alarm

The default output name for any Kessil IoTa device is **Kessilxx_#_1**; The xx will be **TB** (for Tuna Blue) or **TS** (for Tuna Sun), and # is the Aquabus address of the IoTa module.

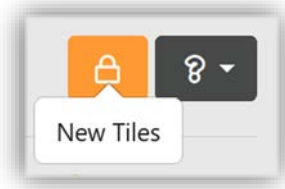
Now go back to the **Dashboard** ; it will show the New Tiles indicator:



Click the **Unlock**  button to show the hidden tiles area, then locate and drag the new tile(s) named KessilTB_#_1, and/or KessilTS_#_1 onto your dashboard and position each one where desired. When done, close the hidden tiles area by clicking on the **Lock**  button again.

MIGRATING A LIGHTING SCHEDULE FROM KESSIL APP TO APEX

Skip to the next section if you have not previously used the Kessil app to control your lights.

Schedules created in the Kessil WiFi app cannot be directly converted or imported into APEX Local or APEX Fusion. If you are changing existing Kessil lighting from control via the Kessil WiFi app to Apex control, take screenshots or make notes about your current lighting schedule so you can refer to them when recreating your current lighting schedule in the Apex.

In the Kessil app, the Kessil Tuna Blue Core (blue and white) is controlled by a single setting which is continuously variable between all blue and all white. Similarly, for Tuna Sun lights, the Tuna Sun Core is continuously variable between 6000K and 9000K white. When under Apex control, blue and white for Tuna Blue lights are split into separate channels. When under Apex control, the Tuna Sun Core is split into separate 6000K and 9000K channels.

In order to facilitate an easy migration from Kessil app to Apex, use these conversion charts to convert from an Kessil app schedule to Apex schedule.

Tuna Blue Core to Apex Conversion			Tuna Sun Core to Apex Conversion		
Kessil Tuna Blue %	Apex Blue Channel %	Apex White Channel %	Kessil Tuna Sun %	Apex 6000K Channel %	Apex 9000K Channel %
0	100	0	0	100	0
5	100	10	5	100	10
10	100	20	10	100	20
15	100	30	15	100	30
20	100	40	20	100	40
25	100	50	25	100	50
30	100	60	30	100	60
35	100	70	35	100	70
40	100	80	40	100	80
45	100	90	45	100	90
50	100	100	50	100	100
55	90	100	55	90	100
60	80	100	60	80	100
65	70	100	65	70	100
70	60	100	70	60	100
75	50	100	75	50	100
80	40	100	80	40	100
85	30	100	85	30	100
90	20	100	90	20	100
95	10	100	95	10	100
100	0	100	100	0	100

This same conversion is presented in graphical form below, along with an example for both Tuna Blue and Tuna Sun lights.

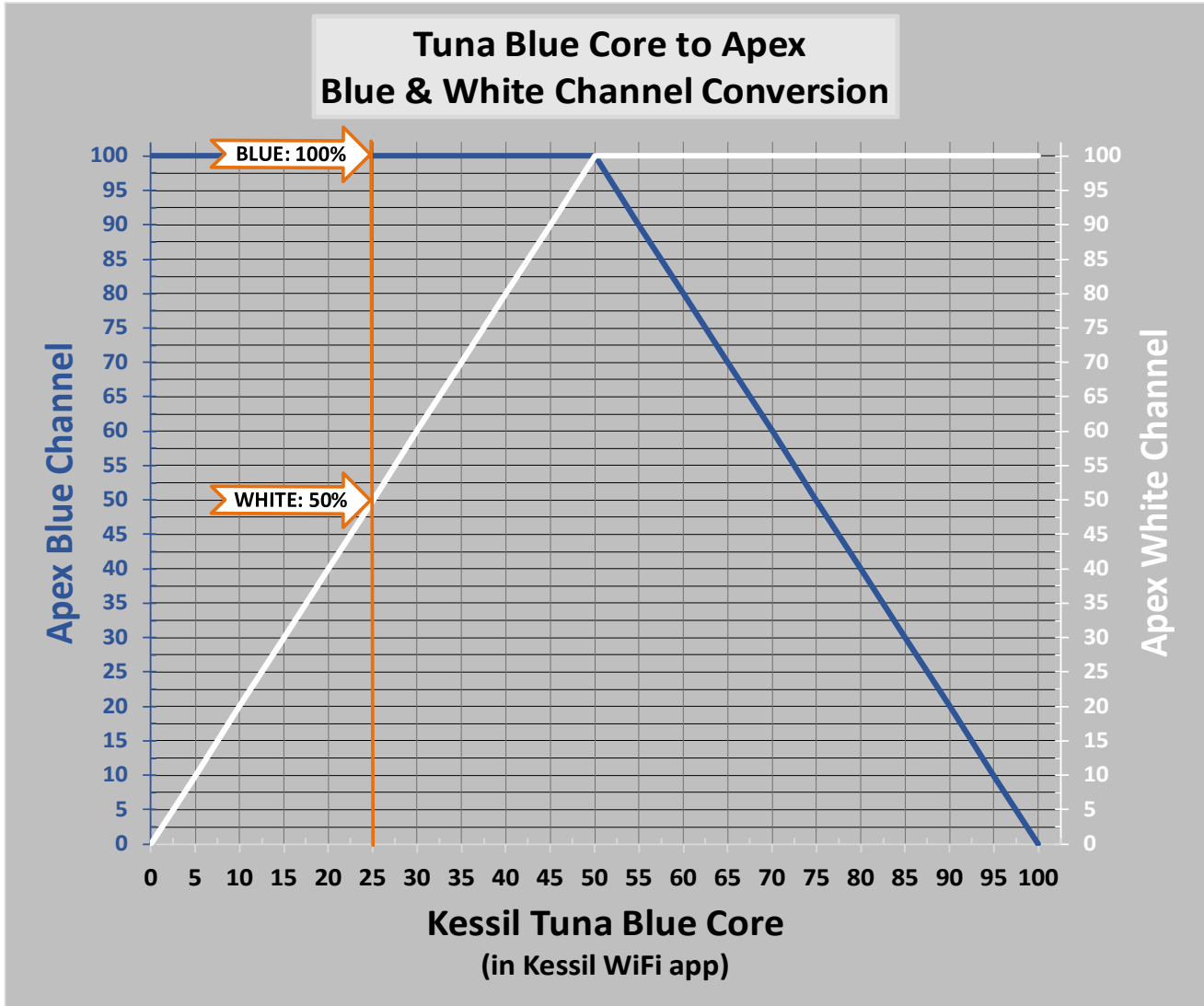

EXAMPLE

You have been using a value of 25 percent in the Kessil WiFi app. To convert that into Apex spectrum slider values for Blue and White, draw an imaginary line upward from 25% on the Tuna Blue axis; the points where that line intersect the blue and white lines are the values to use in the Apex schedule for that light.

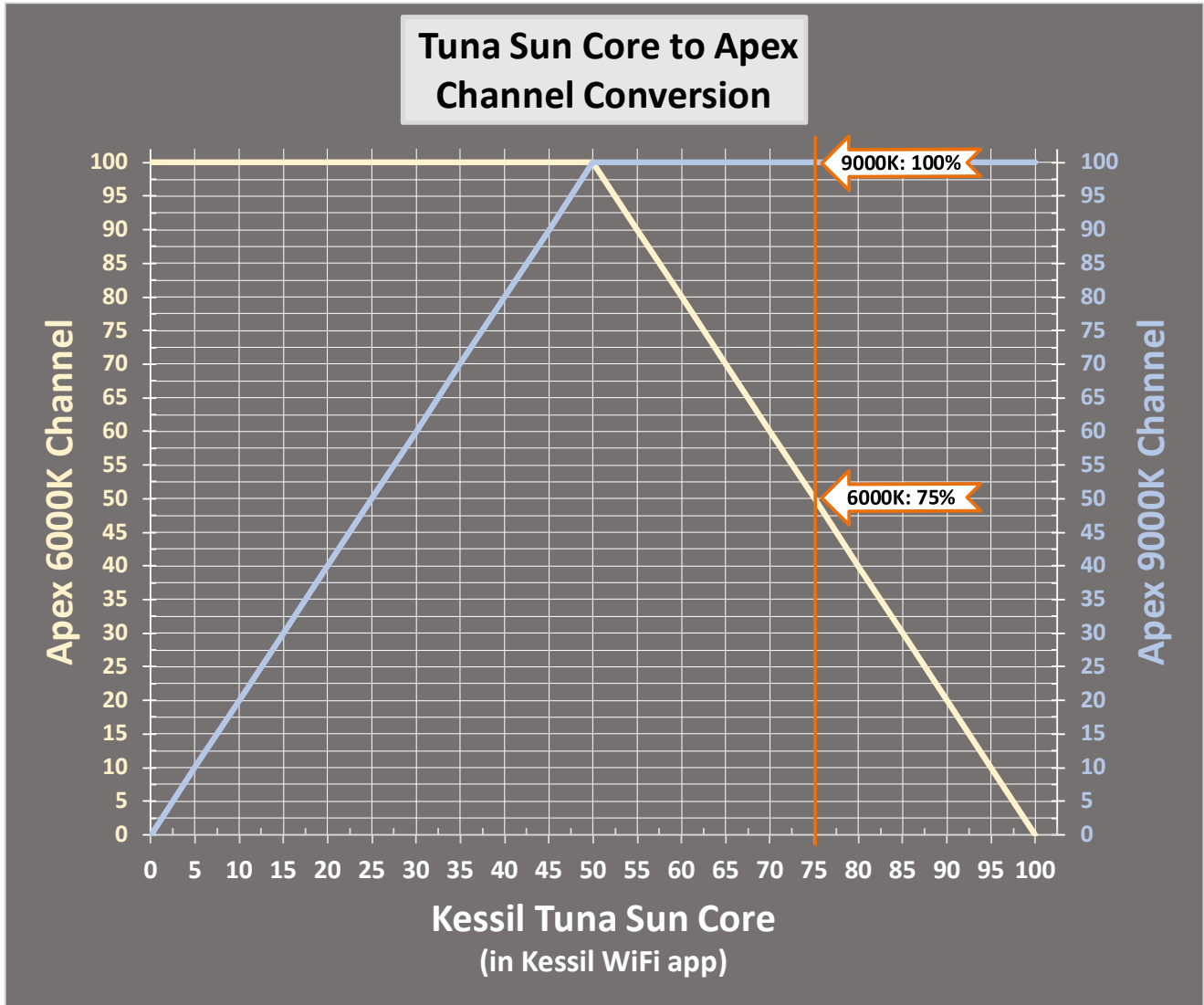

EXAMPLE

You have been using a value of 75% percent in the Kessil WiFi app. To convert that into Apex spectrum slider values for Blue and White, draw an imaginary line upward from 75% on the Tuna Sun axis; the points where that line intersect the bluish and whitish lines are the values to use in the Apex schedule for that light.

CREATING A SCHEDULE FOR YOUR KESSIL LIGHT

To create a schedule for your newly-attached Kessil light, locate its dashboard tile and click the  on the tile. The lighting wizard with a sample lighting schedule will be shown. Use this as starting point.



Modify the schedule as desired by dragging each schedule points to adjust the time and overall intensity. Add an additional schedule point by clicking on the  for a point then clicking on Add Point. You can also adjust the time and intensity for a point, or remove a point.

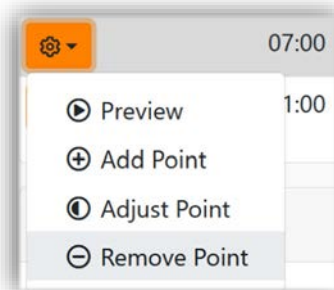

For each point, choose the color spectrum desired. Optionally, enable random cloudy effects for a point by clicking in the checkbox next to the  symbol.

To define a custom spectrum, use the vertical sliders in the Spectrum box to adjust the desired intensity for each color channel.

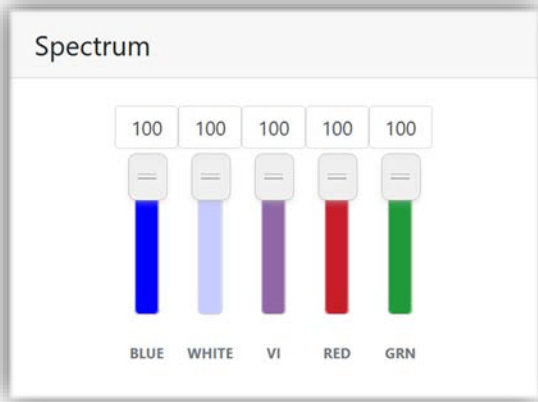

Spectrum sliders for AP9X & A360X Tuna Blue

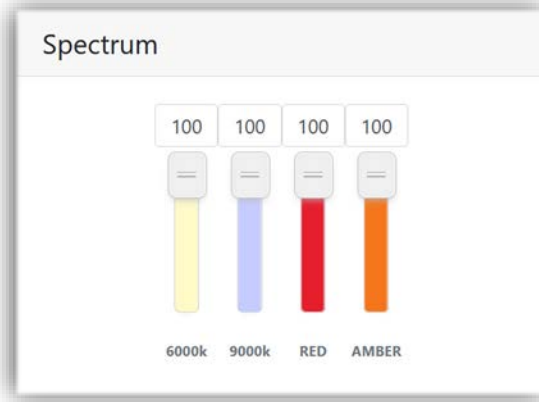

Spectrum sliders for A360X Tuna Sun

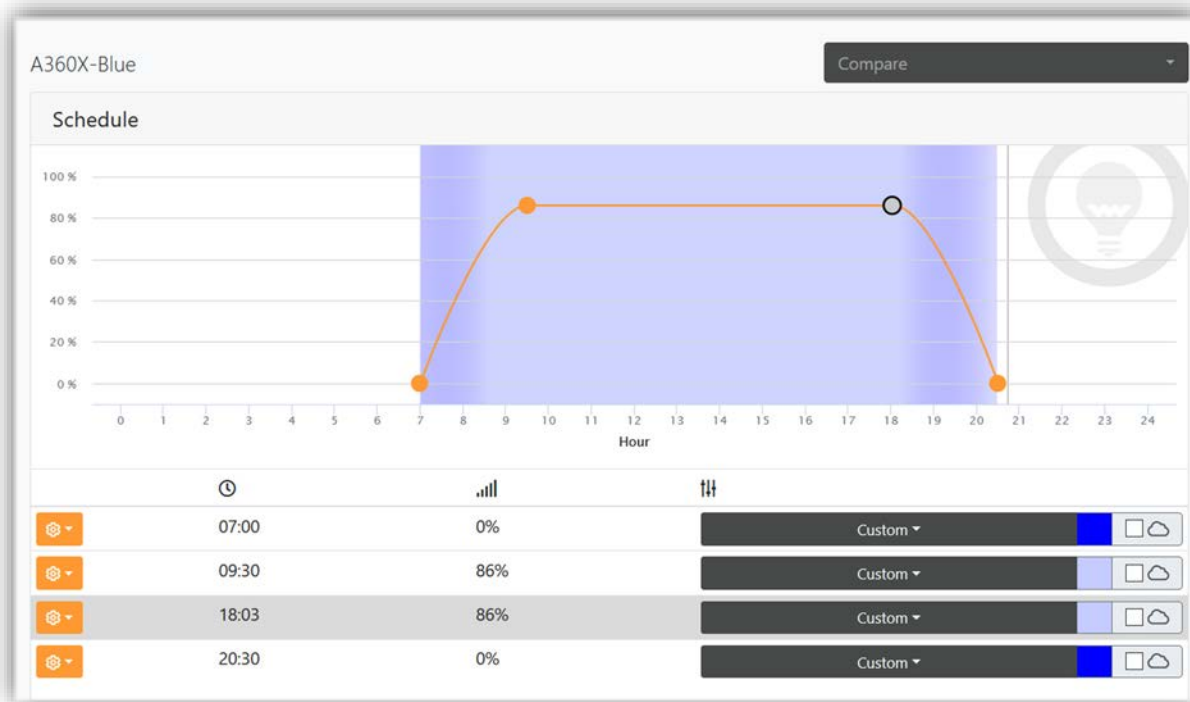

After creating your lighting schedule, assign a custom name to the output by clicking on the **Configuration**  in the upper right corner.

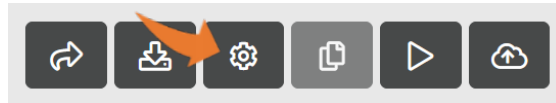

Edit the default output name to give it a descriptive and meaningful name; click the **OK** button when done.

Configuration

Basic **Advanced**

As this type of light is very powerful, **Fallback OFF** is recommended.

Device

Location Output on the IOTA Module named IOTA_4 at Aquabus address 4.

Name

Icon



Fallback

Log Enable

When finished creating your lighting schedule, send it to the Apex by clicking the **Update APEX**  button.



LIGHTING SCHEMES

The IoTa lighting wizard in APEX Fusion supports the use of Schemes, which are lighting schedules that can be saved for your own later use and can also be shared with other Apex owners.

- To save a lighting schedule as a Scheme, click the **Save Scheme**  button.
- To search for Schemes shared by others, click the **Download Scheme**  button. Schemes are available only in APEX Fusion; they are not available in APEX Local.
- You can save a Scheme, then load it onto another IoTa light of the same model.
- Schemes are vendor- and model-specific:
 - ❌ A Scheme created from a Aqualllumination brand light, for example, cannot be used with a Kessil output.
 - ❌ A Scheme created from a AP9X cannot be used with a A360X.
 - ❌ A Scheme created from a A360X Tuna Sun cannot be used with A360 Tuna Blue.

ADDITIONAL INFORMATION

- ❖ The use of Apex profiles is not supported with IoTa outputs.
- ❖ Schedules created in the Kessil WiFi app cannot be converted or imported into APEX Local or APEX Fusion.
- ❖ Fallback is not supported.

Additional detail about an attached Kessil light is available on the Modules view. To see that information, start on the **Dashboard** . Click or tap on the **Expand**  button, click or tap the **Modules**  button, then select the desired IOTA Module. You will see the detailed status on the IOTA Module view:

Of primary interest here is the model and IP address of the Kessil light. Note that A360X lights will appear here as “Wifi Dongle”.

The serial number shown here is the same as the identifier on the QR code sticker that came with each Kessil light.

Summary	
IOTA Module named IOTA_3 at Aquabus address 3.	
Type	IOTA
Name	IOTA_3
Address	3
Status	Connected
Vendor	Kessil
Model	Wifi Dongle
Serial	L4KSG71086
MAC	9e65f903d802
IP Address	192.168.3.218

Summary	
IOTA Module named IOTA_4 at Aquabus address 4.	
Type	IOTA
Name	IOTA_4
Address	4
Status	Connected
Vendor	Kessil
Model	AP9X
Serial	L4KUG50293
MAC	5ef3700e4662
IP Address	192.168.3.215

CHANGE LOG

1.0 8/17/2021 Initial release